

Amana®

**Halogen Plus™ Self-Cleaning Range
Use & Care Manual**

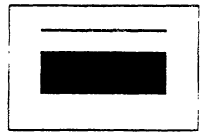

**Model:
ARH665E/WW**

CONTENTS

For Safety's Sake -	
Important Safety Instructions	3
Installation Instructions	5
Range Features	6
Cookware Tips	7
How to Start Rangetop Cooking	8
Rangetop Setting Suggestions Chart	9
How to Clean the Rangetop	10
Chart for Special Rangetop Cleaning	11
Electronic Oven Control	12
Setting the Timer	13
Baking	14
Timed Baking	15
Broiling	16
Self-Cleaning the Oven	18
Storage Drawer	20
Care and Cleaning of Other Oven Parts	21
How to Replace the Lights	21
Commonly Asked Questions	22
Amana Toll-Free Consumer Information Line	23
Asure Extended Service Plan	23

For future reference, record basic range information found on product serial plate and retain a copy of your sales receipt for proof of purchase. The product serial plate is located on oven frame below oven door (open oven drawer to see plate).

Model No. _____

Mfg. No. _____

Serial No. _____

Date Installed _____

Selling Dealer _____

Retain these numbers and your Sales Receipt for proof of purchase should warranty questions arise. Your Sales Receipt is required if warranty service is needed. Complete the registration card, which is included with the packet that comes with the range. This must be filled out and returned to Amana Refrigeration, Inc.

Note: Instructions for setting the electronic clock are on page 5.

IMPORTANT SAFETY INSTRUCTIONS

CAUTION

To Avoid the Risk of Personal Injury Use this appliance only for its intended purpose as described in this manual.

Do not store items of interest to children in cabinets above a range or on the backguard of a range — children climbing on the range to reach items could be seriously injured.

Do not touch surface units or areas near units — Surface units may be hot even though they are dark in color. Areas near surface units may become hot enough to cause burns. During and after use, do not touch, or let clothing or other flammable materials contact surface units or areas near units until they have had sufficient time to cool.

Among these areas are the cooktop and surfaces facing the cooktop.

CAUTION

Do not touch heating elements or interior surfaces of oven — Heating elements may be hot even though they are dark in color. Interior surfaces of an oven become hot enough to cause burns. During and after use, do not touch, or let clothing or other flammable materials contact heating elements or interior surfaces of oven until they have had sufficient time to cool. Other surfaces of the appliance may become hot enough to cause burns. Among these surfaces are oven vent openings and surfaces near these openings, oven door and window of oven door and oven racks.

All Appliances:

1. Proper Installation — Be sure your appliance is properly installed and grounded by a qualified technician.
2. Never Use Your Appliance for Warming or Heating the Room.
3. Do Not Leave Children Alone — Children should not be left alone or unattended in area where appliance is in use. They should never be allowed to sit or stand on any part of the appliance.
4. Wear Proper Apparel — Loose-fitting or hanging garments should never be worn while using the appliance.
5. User Servicing — Do not repair or replace any part of the appliance unless specifically recommended in the manual. All other servicing should be referred to a qualified technician.
6. Storage in or on Appliance — Flammable materials should not be stored in an oven or near surface units.
7. Do Not Use Water on Grease Fires — Smother fire or flame with a non-flammable lid, or use dry chemical or foam-type extinguisher.
8. Use Only Dry Potholders — Moist or damp potholders on hot surfaces may result in burns from steam. Do not let potholder touch hot heating elements. Do not use a towel or other bulky cloth.

Surface Cooking Units

1. Use Proper Pan Size — This appliance is equipped with one or more surface units of different sizes. Select utensils having flat bottoms large enough to cover the surface unit heating element. The use of undersized utensils will expose a portion of the heating element to direct contact and may result in ignition of clothing. Proper relationship of utensil to burner will also improve efficiency.
2. Never Leave Surface Units Unattended at High Heat Settings — Boilover causes smoking and greasy spillovers that may ignite.
3. Glazed Cooking Utensils — Only certain types of glass, glass/ceramic, earthenware, or other glazed utensils are suitable for rangetop service without breaking due to the sudden change in temperature.
4. Utensil Handles Should Be Turned Inward and Not Extend Over Adjacent Surface Units — To reduce the risk of burns, ignition of flammable materials, and spillage due to unintentional contact with the utensil, the handle of a utensil should be positioned so that it is turned inward, and does not extend over adjacent surface units.

Ovens

1. Use Care When Opening Door — Let hot air or steam escape before removing or replacing food.
2. Do Not Heat Unopened Food Containers — Build-up of pressure may cause container to burst and result in an injury.
3. Keep Oven Vent Ducts Unobstructed.
4. Placement of Oven Racks — Always place oven racks in desired location while oven is cool. If rack must be moved while oven is hot, do not let potholder contact hot heating element in oven.

Self-Cleaning Ovens

1. Do Not Clean Door Gasket — The door gasket is essential for a good seal. Care should be taken not to rub, damage, or move the gasket.

FOR SAFETY'S SAKE CONT.



WARNING

This product contains or produces a chemical or chemicals which may cause serious illness or death and which are known to the State of California to cause cancer, birth defects or other reproductive harm.



WARNING

To reduce the risk of tipping of the appliance, the appliance must be secured by properly installed anti-tip devices. To check if the devices are installed properly, remove (necessary part or parts) and verify that the anti-tip devices are engaged.

In case of grease fires



2. Do Not Use Oven Cleaners – No commercial oven cleaner or oven liner protective coating of any kind should be used in or around any part of the oven.
3. Clean Only Parts Listed in Manual.
4. Before Self-Cleaning the Oven – Remove broiler pan, other utensils, and oven racks.

Conventional Coil Cooking Surfaces

1. Do Not Cook on Broken Cooktop – If cooktop should break, cleaning solutions and spillovers may penetrate the broken cooktop and create a risk of electric shock. Contact a qualified technician immediately.
2. Clean Cooktop with Caution – If a wet sponge or cloth is used to wipe spills off a hot cooking area, be careful to avoid steam burn. Some cleaners can produce noxious fumes if applied to a hot surface.

Ventilating Hoods

1. Clean Ventilating Hoods Frequently – Grease should not be allowed to accumulate on hood or filter.
2. When flaming foods under the hood, turn the fan off. The fan, if operating, may spread the flame.

IN CASE OF FIRE

Due to the nature of cooking, fires can occur as a result of overcooking, excessive grease, or component failure. Though a fire is unlikely, if one occurs proceed as follows:

Surface Element Fires

1. DO NOT turn on a range vent hood. The flames could be drawn into the hood where more damage could result.
2. Smother the fire with a non-flammable lid or baking soda, or use a Class “ABC” or “BC” extinguisher. Not water. Not salt. Not flour.
3. As soon as it is safe to do so, turn the surface element controls to “OFF.”

Oven Fires

1. If you see smoke from your oven, **do not open the door.**
2. Turn the oven control to “OFF.”
3. As an added precaution, turn off the power at the main circuit breaker or fuse box.
4. Turn on the range vent hood or exhaust fan, if you have one, to remove smoke.
5. Allow food or grease to burn itself out in the oven.

OF COURSE, IF SMOKE AND FIRE PERSIST, CALL THE LOCAL FIRE DEPARTMENT.

If there is any damage to components, call your repair service before using the range or cooktop again.

Remember, excessive grease is always a fire hazard. The best prevention is to keep your range or cooktop clean and free of excess grease.

FOR SAFETY'S SAKE CONT.

IMPORTANT

To avoid damage to oven elements or uneven baking results, do not place aluminum foil on the oven bottom, oven heating element or over an entire oven rack.

IMPORTANT PRECAUTIONS

- Do not cook food directly on the cooktop surface; always use cookware.
- Do not mix household cleaning products. Chemical mixtures may interact, with objectionable or even hazardous results.
- Do not put plastic items on warm cooking areas. They will stick and melt.
- Do not slide rough metal objects across range top surface. Scratching or metal marking can result.
- Do not use cookware with rough bottoms. They may scratch surface. Glass and glass-ceramic cookware can be used on coil element.
- Do not use sponge or dishcloth to clean top. They can leave film of soil-laden detergent water on unit. If this should happen, Amana ASAP™ Cleaner-Conditioner will remove the stain.
- Do not use aluminum foil or place foods packaged in aluminum foil directly on the rangetop for cooking. Direct use of foil can damage the rangetop.
- Do not leave fat heating unless you remain nearby. While the heating areas are cooler during cooking than most rangetops, fats can ignite if overheated by spilling onto hot surface.
- Do not "flame" foods under vent hood with fan on. If operating, the fan could spread the flame.
- Do not heat unopened food containers. Pressure buildup can cause container to burst and result in injury.
- Do not allow pots to boil dry on high settings as this can cause damage to the cooking surface and the pan.
- Do not use the rangetop surface as a cutting board.

INSTALLATION INFORMATION

For detailed instructions on proper installation, refer to the installation instructions included with the range.

You can install an optional vent hood ventilation system above your range. Consult your Amana dealer for more information about Amana vent hoods. Remember, it is important to clean a vent hood frequently to prevent the risk of fire.

TO INSTALL:

CAUTION

To Avoid the Risk of Electrical Shock, Personal Injury, or Death:

Your range must be properly grounded and installed by a qualified installer. It is the personal responsibility and obligation of the customer to contact a qualified electrician/installer and have the unit connected to a properly grounded circuit in accordance with the National Electric Code.

TO SET THE ELECTRONIC CLOCK:

When your range is initially powered (or when power has been interrupted) the display will first flash the time of day when power was interrupted. Next, the word "door" will flash in the display indicating that the electronic control is ready to diagnostically check the door's automatic locking mechanism as a safety measure. Follow these steps to check door and to set the electronic clock.

1. Open oven door and raise the **window heat shield** by sliding the two side guides toward the top of the door until both snap into holding position.
2. Close oven door. Wait until you hear the oven lock and unlock automatically as it checks the lock mechanism.
3. Open oven door again and lower **window heat shield**. Close oven door. The word "door" will now disappear from the display.
4. Push CLOCK button once. Time digits will stop flashing and "Time" will appear in display.
5. Turn TIME SELECT knob in either direction for correct time of day. Push CANCEL button once to set time (this will not cancel programmed time). Time of day will now show in the display.

To change the clock time at any time, repeat steps 4-5 above.

Note: This is a 12-hour clock which does not distinguish between AM and PM.

HALOGEN-PLUS FEATURES

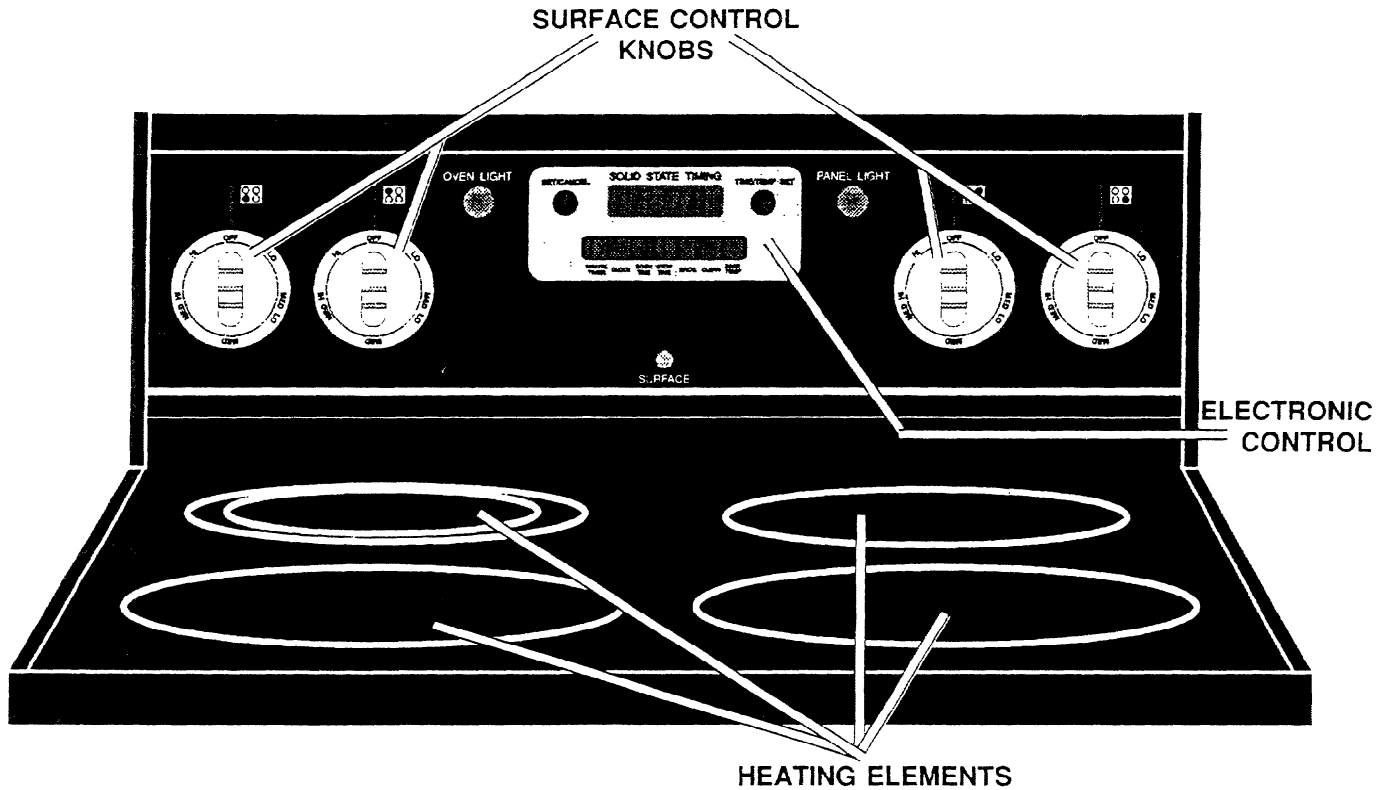

Your new Halogen Plus™ Smoothtop Rangetop blends the beauty of a glass-ceramic cooktop with a high performance cooking system. All of the cooking elements heat up quickly and evenly for good cooking performance. The quartz halogen heating elements are uniquely designed with a circular quartz halogen lamp (vacuum-sealed quartz glass tube filled with halogen gas) which produces virtually instantaneous heat and glowing light when turned on. In addition, these halogen elements each have a resistance coil element located in the center which adds and distributes heat to further ensure even cooking performance. Your rangetop also features electric resistance heating elements. These provide a visual response much quicker and brighter than conventional coil elements. One of the elements is a dual element. It provides the convenience and versatility of both a 5½" and 9" element.

The push-to-turn control knobs have an infinite number of settings so you can easily control the element. The elements will cycle off and on to maintain the desired setting. Each cooking area has an indicator light located by its corresponding control knob. For safety's sake, the indicator lights glow red when the corresponding elements are turned on. After the elements are turned off, the lights remain illuminated until the cooking surface areas have cooled down to a safe temperature. Use the retained heat, indicated by these indicator lights, to finish cooking or keep foods warm.

Each heating element also has a temperature limiter to protect the glass-ceramic cooking surface from possible damage caused by overheating. The range is easy to keep clean since the control knobs can be removed for cleaning and the frame completely seals the rangetop surface to prevent liquids from seeping inside.

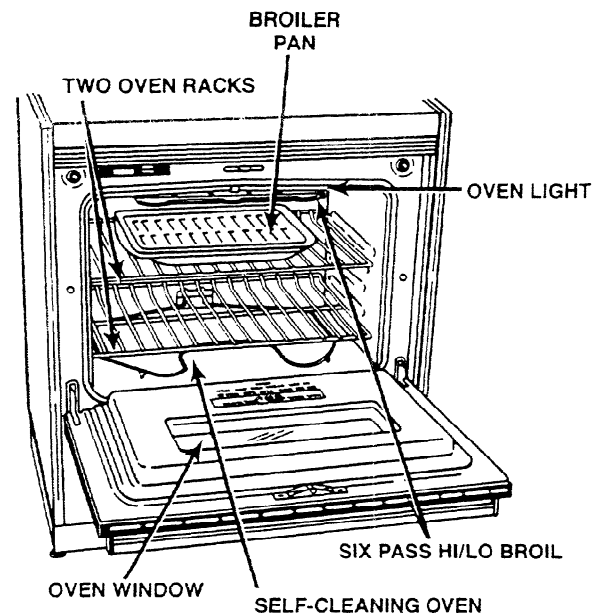

COOKWARE TIPS

The correct cookware is important for the best cooking results on your rangetop. **We recommend using medium to heavy gauge metal cookware which have flat, smooth bottoms for best cooking results and for maintaining the beautiful appearance of the rangetop.**

The flatter the utensil's bottom surface, the better it will be able to receive heat from the element and conduct heat to the food. Flat cookware will be the most efficient and will give the best cooking performance.

When we say flat, we mean all-over flatness without grooves, recessed bottoms, other dents or warpage. One check of flatness is to place a straight edge ruler perpendicular to the bottom. Rotate the straight edge a full 360° around the bottom, checking for flatness in all directions. If there is no gap between the ruler and the bottom of the pan, it will cook satisfactorily. Some bottoms of metal pans may become "flat" when heated, so the best guideline is: TRY THE PAN.



Aluminum, stainless steel and other metal cookware that is flat on the bottom will conduct heat quickly. Cookware with thick disk-like bottoms work very well on the glass-ceramic surface because they are durable and remain flat with use.

Note: Because glass and glass-ceramic cookware are not good heat conductors, they are not recommended for use on this rangetop. Small imperfections in the bottom surface of glass, glass-ceramic and porcelain-coated cookware can scratch the glass-ceramic rangetop surface permanently.

Cast iron cookware should be used for heat settings no higher than medium. Cast iron can retain high temperatures even after the cooking element is turned off which could damage the glass-ceramic cooktop. Use cast iron for short term, low heat cooking.

Many metal pans may contain aluminum which can deposit markings on the rangetop. These markings can be removed by using ASAP™ Cleaner-Conditioner and a nonabrasive nylon cleaning pad. Remove metal marks before the next use, since they become harder to remove when surface is heated again.

Also look for cookware that closely matches the size of the elements (with no more than 1-inch overlap) for the most efficient cooking.

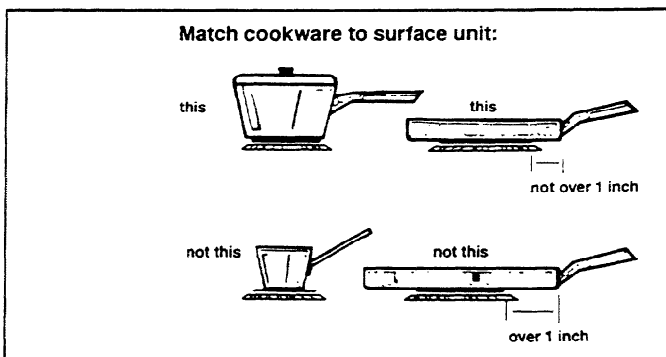

WHICH UTENSILS TO USE?

For best cooking results, efficiency and safety, always use cookware which:

1. Is flat.
2. Stays flat when heated.
3. Most closely matches the size of the heating area.
4. Is well balanced.
5. Has a tight-fitting lid.
6. Is made of a medium to heavy gauge metal which conducts heat well.

For further information on cookware, canning utensils, and woks, call the Amana Toll-Free Consumer Information number (1-800-843-0304).

Remember:

- Do not use aluminum foil or place foods packaged in aluminum foil directly on the rangetop for cooking. This can damage the rangetop surface.
- Do not use rangetop surface as a cutting board.
- Do not put plastic, paper, or cloth items on rangetop. Such items can burn or melt on contact with hot surfaces.
- As with all cooking appliances, place cookware on the cooking area before turning the appliance on.

CANNING AND WOK USAGE

You can use your rangetop for canning. The bottom of the canning container should have the same characteristics that are recommended for regular cookware (i.e. flat bottoms). Avoid canners with flanged or grooved bottoms. Make sure that the canning container does not touch the rangetop frame. If the bottom rests on the frame, it will not be in complete contact with the heating area and cooking times will be increased. If your rangetop does not allow the canner to be centered on the surface element, use smaller diameter containers for good canning results.

Remember to cover containers such as water bath canners, for faster heating. Remember, in following the recipes, canning is a process that generates large amounts of steam. Use care when canning to prevent burns from steam or heat. Follow the canning instructions given in any standard cookbook or supplied by the canner manufacturer. Some manufacturers give instructions for using pressure canning containers for better water bath canning results. Check manufacturers instructions for further details.

Note: If your range is being operated on low power (voltage), canning may take longer than expected, even though directions have been carefully followed. The process may be improved by 1) using a pressure canner, and 2) beginning with hot tap water for faster heating of large quantities of water and 3) keeping containers covered.

For best results in wok cooking, it is recommended you use a flat-bottomed wok or stir fry pan instead of a wok with a ring stand. Woks with ring stands are designed for use on gas burners and electric coil elements only.

HOW TO START RANGETOP COOKING

You will find that your rangetop will serve you best if you remember some of its special features when you start to cook, and follow the suggested steps that appear below. They can help you avoid unnecessary cleaning, prevent overcooking and save on electrical power.

To use the rangetop heating elements, follow these basic steps:

1. Make sure bottom of cookware and cooking area are **clean, dry, and smooth**. In regions where there is abundant sand or dust, use a damp paper towel to remove surface particles before using.
2. Center cookware on a cooking area which most nearly matches the size of the bottom of the cookware.
3. Push in and turn **control knob** to start cooking. As a safety feature, the knobs must be pushed in before they can be turned. A chart of suggested settings is on page 9.

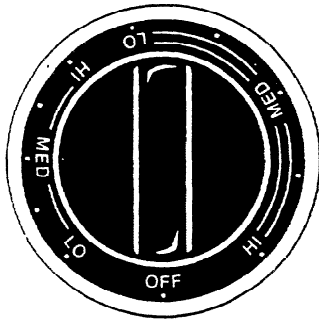

Your Amana range features a dual element. You can use either the entire element (9") or only the center portion (5½") for cooking. You will love the added convenience this element offers and its ease of use.

To use the element, you will notice that the control knob has two sets of temperature settings. The double line indicates that you are using the entire element (9"). The settings connected by the single line should be selected when using the center portion (5½") of the element. This center portion is great for small pans and for keeping foods warm.

You will love the added convenience this element offers and its ease of use.

4. Reset the **control knob** as necessary for required changes in cooking. On some occasions it might be helpful to use the oven timer, see page 13 for instructions. Also, use the panel light by pressing the panel light button, if desired.

The controls will cycle the elements off and on so that the setting you have selected will be properly maintained. When the selected setting is reached, the element turns off and then it will cycle on again to maintain the desired setting. For example, the higher the setting you select, the more often the element will cycle on and the less it will be off. Even on the HI setting the elements will cycle. On a low setting, the element will cycle off more often.

Note: The glass-ceramic rangetop will retain some of the heat generated during cooking so allow time for temperature to come down after turning the heat setting lower.

It's wise to start with a lower setting and increase heat gradually if needed. Quicker changes in cooking action can be observed when settings are turned up rather than when settings are turned down due to the retained heat in the rangetop cooking areas.

The control knobs have individual hot indicator lights which correspond with the location of the surface heating areas. They glow red to show which surface areas are turned on.

WHEN ANY SURFACE ELEMENT IS TURNED OFF, THE INDICATOR LIGHT REMAINS ON UNTIL THE CORRESPONDING SURFACE HEATING AREA IS AT A SAFE TEMPERATURE. The amount of heat in any surface heating area is determined by the length of time the element is on and the type of pan used as well as the control knob setting. Therefore, the length of time each light remains on will vary. Do not expect the lights for two opposite heating areas to go off at the same time even if the elements are turned off simultaneously. Use the retained heat as, indicated by these lights, to finish cooking or keep foods warm.

HELPFUL HINTS

- When bringing to boil use "Hi" setting and cover cookware.
- Some foods, such as eggs, are more sensitive to heat than others and cook in a short period. With foods that tend to scorch or burn easily, start with the lowest recommended setting.
- When turning the setting down to slow the rate of cooking, allow time for the retained heat in the cookware and cooking area to lower. It's wise to start with a lower setting and increase heat gradually, if needed.
- When cooking is almost completed, make use of the heat retained in the cookware and cooking area to finish the cooking. Turn the control knob to "OFF" and leave the cookware in place until cooking is finished or to hold foods for serving.
- If boilover develops, remove the cover or take the cookware off the cooking area, moving it to a non-cooking area, until the surface has had time to sufficiently cool, then carefully wipe the area clean and continue cooking.
- To cool a cooking area down quickly after cooking is completed, place a pan of cool water on the cooking area to absorb the residual heat.

RANGETOP SETTING SUGGESTIONS CHART

The following chart outlines suggested rangetop settings for various foods and cooking methods. Remember, these are suggestions; cooking temperatures will depend on the cookware and quantity of food being cooked, as well as the control knob setting.

The dual element gives you added versatility by accommodating different sized pans. Use the entire element (settings marked with double lines) for larger pans with larger amounts of food. The center portion of the dual element (settings marked with single line) is ideal for small saucepans. Try it for preparing small quantities of food such as when cooking sauces and puddings, melting chocolate and butter, reheating leftovers, as well as holding foods to keep them warm.

Cooking Method	Foods	Control Knob Setting
Blanching	Fruits, Vegetables, Nuts	HI
Boiling	Cereals — boil water — cook Pastas — boil water — simmer Vegetables — boil water — cook	HI LO HI MED LO to MED HI MED LO to MED
Braising	Meats and Poultry	MED LO
Deep Fat Frying ¹	Vegetables, Meats, Pastry, etc. — to heat oil (adjust setting to maintain desired temperature.)	HI
Frying, Grilling ²	Eggs Meats — Bacon patties, chops, steaks Pancakes, French Toast Grilled Sandwiches	LO to MED LO MED LO to MED MED LO to MED MED LO to MED MED to MED HI
Melting	Butter, Chocolate, Cheese	LO to MED LO
Pressure Cooking	Meats, poultry, vegetables (use adequate amount of liquid) — bring to pressure (adjust setting to maintain pressure)	HI
Simmering	Soups, Sauces, Meats	LO to MED LO
Slow Cooking	Meats, Stews, Sauces	LO to MED LO
Steaming	All Foods (cover) — boil water — maintain steam	HI LO to MED LO
Warming — Holding	Leftovers (cover) Holding foods ³	MED LO LO

¹ Use metal utensil only.

² Preheat skillet for patties, chops, steaks, searing roasts, pancakes, French toast and grilled sandwiches.

³ For safety, meat, milk, poultry, eggs and fish products should never be held more than two hours.

Hints for Deep Fat Frying on Rangetop

Deep fat frying on the glass-ceramic rangetop may be somewhat different than what you are used to. Because the glass-ceramic surface retains heat so well, the settings should be turned down before the oil reaches the desired end temperature. Learn to think ahead so you can adjust the setting while allowing for the retained heat to be used.

When deep fat frying, fill and heat oil to temperature as indicated in recipe. For best results, use a deep fat frying thermometer. Place thermometer so that the bulb does not touch the bottom or sides of the pan. Add food in quantities small enough to keep the temperature of the fat from dropping drastically. Keep temperature of fat as constant as possible for best results.

Remember to use caution when working with hot oil or fat.

HOW TO CLEAN THE RANGETOP

1. Save on clean-up time:

- Make sure bottom of cookware and cooking area are **clean** and **dry** before using cooktop.
- Select correct heat settings and use cookware large enough to accommodate food and liquid to eliminate boilovers and spattering.
- If possible, wipe up food spills and spatters as well as metal markings from adjacent heating areas before using such areas for cooking.
- Use a spatter shield when shallow frying.

2. Daily Care:

- Use only ASAP™ (Amana Service Authorized Parts) Cleaner-Conditioner to clean and condition the rangetop. Do not use other cleaners.
- Apply a **small** amount of cleaner and with dampened clean **paper towel**, clean rangetop surface. Wipe off this application with another clean, damp paper towel then wipe dry.

Helpful Hint: Use only paper towels when cleaning the cooktop — sponges or dishcloths can leave a film of soil-laden detergent water on the glass-ceramic surface which can dull or discolor the rangetop when heated again.

- If surface becomes dull, hazy or heavily soiled: Use ASAP™ Cleaner-Conditioner to help prevent or remove such discolorations.

3. How to deal with burned-on spots:

- Make sure area to be cleaned is cooled. To cool quickly, you can place a pan filled with cool water on the area.
- Carefully remove excess soil with a single-edge razor blade or Gillette Widget® (see illustration).



- Clean off remainder of burn-on with ASAP™ Cleaner-Conditioner and a damp paper towel or a nonabrasive cleaning pad.

NOTE: Avoid sliding metal items across the glass-ceramic surface. This can cause metal markings on the rangetop. Metal markings should be taken off as soon as rangetop has cooled by following routine care and burned-on spots instructions listed above. Metal markings will become more difficult to remove if they are not removed before the cooktop is used again.

NOTE: Wipe up spillovers that contain sugar immediately (while cooking surface is still warm, not hot) with dry wadded paper towels. If sugar or sugar syrup are allowed to burn on, they may pit the surface of the glass-ceramic.

CLEANING HINTS

- If a damp paper towel is used to remove spillovers from a warm cooking area, be careful to avoid steam burns.
- Never mix household cleaning products! Chemical mixtures may interact with objectionable or even hazardous results.

- Do not use sponges or dishcloths. They may leave a film of soil-laden detergent water on heating area. If that should happen, ASAP™ Cleaner-Conditioner should remove the stain.
- Wait until rangetop has cooled before cleaning. Some cleaners may emit fumes that could be hazardous.
- Make sure diamond rings do not come in contact with the glass-ceramic surface when cleaning or cooking. They could scratch the surface.



CAUTION

Do not use cleansers on any hot surface. Any resulting fumes can be hazardous.

Use non-abrasive cleaners. Amana ASAP™ Cleaner-Conditioner can be purchased from your Amana dealer.



CLEANING MATERIALS

Do use

ASAP™ Cleaner-Conditioner should be used regularly to clean and protect the cooking surface. If you should run out, you may temporarily use one of the following: BON AMI®, SOFT SCRUB® (non-bleach formula), or baking soda. Also use nonabrasive plastic and nylon pads when cleaning. Some examples are: DOBIE® scouring pad, SCRUFFY® scouring brush and TUFFY® plastic mesh ball. The Gillette Widget® (a disposable scraper) and the O-CEL-O® Scrub (a yellow oval scrubbing pad) can be used in conjunction with the Amana ASAP™ Cleaner-Conditioner to remove burned-on spots.

Do not use

Some cleaning materials recommended by manufacturers for general use on "glass" may contain ingredients which can damage the rangetop. Use only the type of materials recommended above.

1. Avoid plastic, nylon and cloth pads which contain abrasive particles such as: RESCUE® brand scouring pads, SCOTCH-BRITE® brand scouring pads, GOLDEN FLEECE® pot cleaner and scour cloths — these can scratch.
2. Avoid metal pads such as CHORE BOY® pot cleaners, KURLY KATE® pot cleaners, S.O.S.® soap pads, PADDY® soap pads — these can etch the glass-ceramic rangetop surface and are caustic.
3. Avoid cleaners which contain **ammonia** or **chlorine bleach**, these can be harmful to the rangetop surface. (Do not use the SOFT SCRUB® formula which contains bleach.) **Do not use Delete or Amana® Stain Remover on rangetop surface. Do not use chemical oven cleaners. Do not use rust-stain removers containing hydrofluoric acid.**
4. Avoid abrasive, heavy-duty cleansing powders such as: Ajax cleanser and Comet cleanser — these can scratch, depending on their abrasiveness and the cleaning pressure applied in use.

See page 21 for instructions on cleaning the control panel of the range.

CHART FOR SPECIAL RANGETOP CLEANING

Problem	Cause	To Prevent	To Remove
Brown streaks and specks	<ul style="list-style-type: none"> • Cleaning with a sponge or dish cloth that has been used for other kitchen cleaning tasks and may contain soil-laden detergent water. 	<ul style="list-style-type: none"> • Use ASAP™ Cleaner-Conditioner with clean, damp paper towel. 	<ul style="list-style-type: none"> • Use a light application of ASAP™ Cleaner-Conditioner with clean, damp paper towel.
Blackened burned-on spots	<ul style="list-style-type: none"> • Spatters or spillovers onto a hot cooking area. • Accidental melting of a plastic film, such as a bread bag or similar items. 	<ul style="list-style-type: none"> • Select correct heat settings and large enough cookware to eliminate boilovers and spattering. • Whenever possible, wipe spatters and food spills as they occur. • Use a spatter shield available in houseware departments and some supermarkets. • Do not put plastic items on warm cooking area. 	<p>When area has cooled:</p> <ul style="list-style-type: none"> • Use ASAP™ Cleaner-Conditioner with damp paper towel to remove as much burn-on as possible. • Use recommended cleanser with nonabrasive plastic nylon pads such as: SCRUFFY® scouring brush, and TUFFY® plastic mesh ball. • If burn-on persists, CAREFULLY scrape with a single edge razor blade or a Gillette Widget®. Hold blade so entire length of edge is on rangetop surface at a 30° angle. Use a blade holder if you have one.
Fine "brown/gray lines" (tiny scratches or abrasions which have collected soil)	<ul style="list-style-type: none"> • Coarse particles (salt, sand, sugar or grit) caught between bottom of cookware and cooktop that are not removed before cooking. • Using incorrect cleaning materials. • Scratching from use of rough glass, glass-ceramic or porcelain-coated cookware. 	<ul style="list-style-type: none"> • In areas where there is an abundance of sand or dust, be sure to wipe rangetop each time before using. • Daily use of ASAP™ Cleaner-Conditioner will clean and protect the rangetop surface. • Do not use glass, glass-ceramic, or porcelain-coated cookware on rangetop. 	<ul style="list-style-type: none"> • Tiny scratches are not removable but can be minimized by continual use of ASAP™ Cleaner-Conditioner. Such scratches do not affect cooking performance.
Smearing or streaking	<ul style="list-style-type: none"> • Use of too much cleanser or use of soiled dish cloth. 	<ul style="list-style-type: none"> • Use small amount of cleanser for regular cleaning. Rinse thoroughly with another clean damp paper towel before drying surface. • Use only paper towels to clean rangetop surface. 	<ul style="list-style-type: none"> • Dampen paper towel with a mixture of vinegar and water and wipe rangetop to remove cleanser residue. Wipe area with another damp paper towel. Dry surface with a paper towel or lint-free cloth.
Metal marking (silverish gray marks)	<ul style="list-style-type: none"> • Sliding or scraping metal utensils across rangetop. 	<ul style="list-style-type: none"> • Do not slide metal objects across rangetop. Lift cookware filled with food, instead of sliding it across the rangetop surface. 	<ul style="list-style-type: none"> • Remove metal marks as soon as surface cools and before cooktop is used again. • Apply ASAP™ Cleaner-Conditioner with dampened paper towel or nonabrasive nylon scouring pad to cooled surface. Rinse and dry surface.
Pitting or flaking	<ul style="list-style-type: none"> • Boilover of sugar syrup and adherence of sugar syrup to hot rangetop. This can cause pitting if not removed immediately. 	<ul style="list-style-type: none"> • Select correct heat settings and large enough cookware to eliminate boilovers and spattering. • Watch sugar syrup carefully to avoid boilover. 	<ul style="list-style-type: none"> • Turn element to LO; take several paper towels and <i>carefully wipe hot cooktop immediately</i>. • Carefully scrape off remainder of burn-on with a single edge razor blade or a Gillette Widget® held at 30° angle while area is still warm. Use a blade holder if you have one.
Hard water spots	<ul style="list-style-type: none"> • In cooking, condensation often collects and drips from cookware covers removed during cooking. • The minerals found in the water supply and acids in foods may spill on the surface and cause a gray deposit. The layer is so thin it often seems to be in or under the cooking surface and cannot readily be felt. 	<ul style="list-style-type: none"> • Always make sure the bottom of your cookware is dry before placing it on the dry cooktop surface. • Daily use of ASAP™ (Amana Service Authorized Parts) Cleaner-Conditioner applied with a clean damp paper towel will help to keep the glass-ceramic surface free from hard water mineral deposits and food-causing discolorations. 	<ul style="list-style-type: none"> • Mix a small quantity of ASAP™ Cleaner-Conditioner or BON AMI® with tap water to form a thick wet paste. Apply to stained area, scrub surface vigorously. • If stain is not removed, reapply cleanser and let it stand for thirty minutes. Then rescrub if necessary, using a nonabrasive nylon scouring pad. • After stain is removed, clean remaining cleanser away with damp paper towel. Dry cooktop surface. • In addition, you can try the cleaning procedure for "smearing or streaking" listed above.

ELECTRONIC OVEN CONTROL

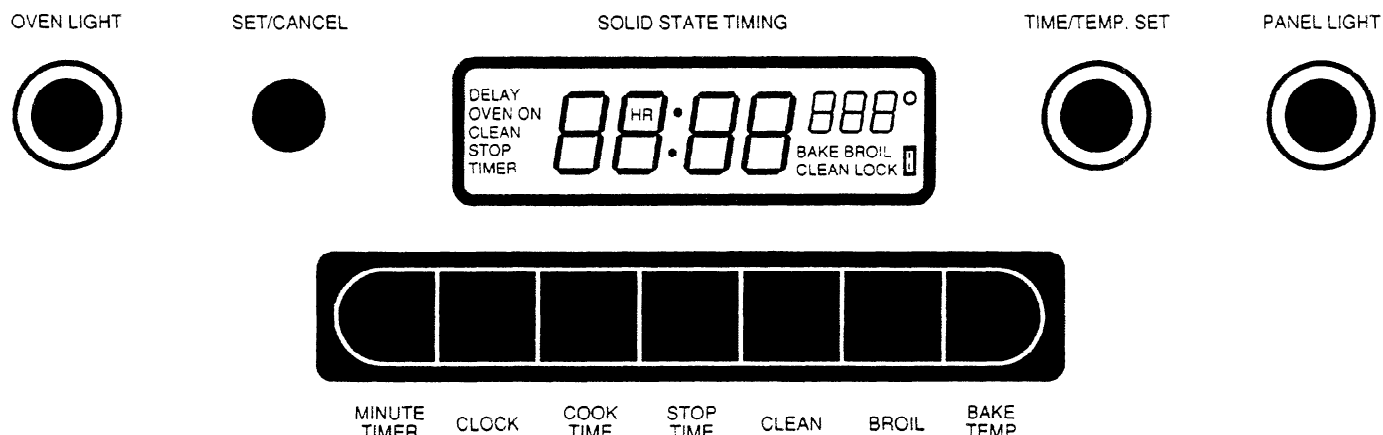

Your range features an easy-to-use electronic oven control. Not only does this control operate all timed baking and cleaning functions, it also controls the oven thermostat to give you precisely controlled baking and broiling.

Control Buttons

CANCEL button – cancels programmed functions and turns oven off. Can be used to cancel mistakes or reprogram the control.

TIMER button – use to time rangetop cooking, oven baking, or other various kitchen activities.

CLOCK button – use to set the time of day.

OVEN TIME button – use to set timed baking functions.

CLEAN button – use to set oven for self-clean cycle.

STOP TIME button – use to set delayed bake and self-clean operations.

BROIL button – use to program broil feature.

BAKE button – use to set any of the bake operations.

TIME SELECT knob – turn to select times and oven temperatures.

Each time these buttons are pressed, you will hear a **confirmation tone**, if this feature has been selected. This confirmation tone is optional and can be deactivated, if desired.

To deactivate the confirmation tone:

1. Push and hold the CANCEL button for approximately three seconds or until you hear the oven control beep once. The confirmation tone is now canceled.
2. To reactivate the confirmation tone, repeat the procedure described in step 1.

Display Features

The words and numbers in the control's display will light up to indicate which functions have been programmed.

The "ON" will light up in the display when the bake and/or broil elements are operating.

The "LOCK" will light up when the door lock lever has automatically locked for the self-clean cycle.

"BAKE," "BROIL" and "CLEAN" on the right hand side of the display will tell you which mode has been selected. "HR" will light up when timed feature is set for a certain number of hours.

Signal Tones

Preheat Tone – after the oven has been programmed for bake, the oven will heat to the selected temperature. When this temperature is reached, the oven control will beep once to let you know the oven is preheated.

End of Cycle Tone – after a timed oven operation is finished, the oven will sound three long beeps. When the Timer feature is used, it will sound three long beeps and then it will beep once every ten seconds until the TIMER button is pushed.

Service Tones - the oven control will sound a series of short, rapid beeps and the display will show a diagnostic service code if there is a problem with the electronic oven control. See page 22 for further instructions.

TO SET THE ELECTRONIC CLOCK:

When your range is initially powered (or when power has been interrupted) the display will first flash the time of day when power was interrupted. Next, the word "door" will flash in the display indicating that the electronic control is ready to diagnostically check the door's automatic locking mechanism as a safety measure. Follow these steps to check door and to set the electronic clock.

1. Open oven door.
2. Close oven door. Wait until you hear the oven lock and unlock automatically as it checks the lock mechanism.

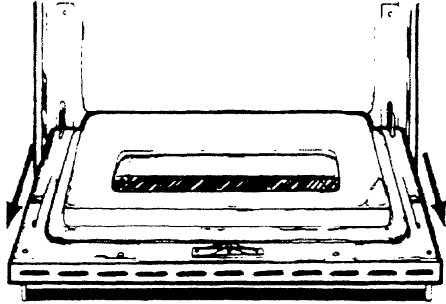

3. Open oven door again. Close oven door. The word "door" will now disappear from the display.
4. Push CLOCK button once. Time digits will stop flashing and "Time" will appear in display.
5. Turn TIME SELECT knob in either direction for correct time of day. Push CANCEL button once to set time (this will not cancel programmed time). Time of day will now show in the display.

To change the clock time at any time, repeat steps 4-5 above.

NOTE: This is a 12-hour clock which does not distinguish between AM and PM.

TO SET THE TIMER:

Use this handy kitchen timer to time baking, rangetop cooking and other various household activities.

1. Push TIMER button once. "TIMER" will show in display.

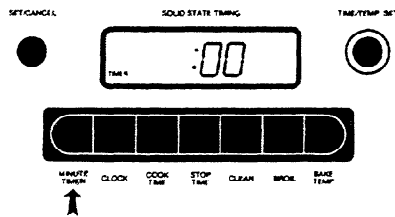

2. Turn the TIME SELECT knob clockwise until you have selected the length of time you want. The timer displays in minutes: seconds up to one hour and then it displays in hours: minutes up to 9 hours and 50 minutes. For example 10 minutes would be 10:00, and 2 hours and 30 minutes would be 2:30 ('HR' will show also).

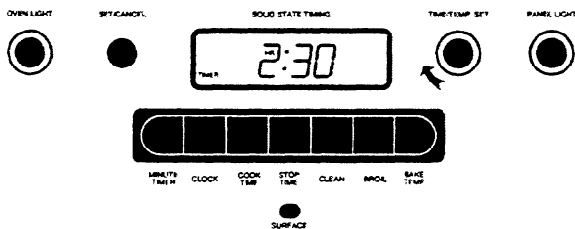

Timer will begin to count down in one second (or one minute) increments. Timer can be programmed for a maximum of 9 hours and 50 minutes. "HR" will show when hours have been programmed.

You can add or delete time as necessary by turning the TIME SELECT knob in either direction.

3. When time has elapsed, the control will sound three long beeps and then will beep once every ten seconds.
 - Push TIMER button to stop beeping and return time of day to display.
4. **To cancel timer**, push and hold TIMER button until time of day shows in display. If the "TIMER" time was not being displayed because another feature was operating, the display will not change but the Timer will be cancelled.

NOTE: The Timer is only a helpful reminder and does not operate the oven. The Timer can be used whether or not the oven is being operated.

BAKING

OVEN HINTS:

- Before oven is turned on and heats, check that oven racks are correctly placed. Oven rack supports on opposite sides of oven provide five rack positions for easy adjustments to any baking or broiling operation.
- Oven racks can be pulled forward to the lock “stops” for safe easy loading and unloading. Racks should have the turned corners in rear.
- Use care when opening oven door – let hot air or steam escape before removing or replacing food.
- Do not let potholder contact hot heating elements in oven if oven rack must be moved while oven is hot.
- Do not place anything directly on heating element in the oven or cover oven vent holes in the oven.
- Avoid frequent door openings. Use oven light and view food through oven door window.
- For possible pie or casserole overflow, cut a piece of aluminum foil slightly larger than the utensil, turn up edges

and place on the rack below. Do not place aluminum foil directly on the oven elements or cover entire rack since this will prevent the oven from functioning properly.

- **To remove rack**, pull out to lock “stop” position, then lift up and out.
- **To replace rack**, place on selected rack supports with turned up corners to the rear and push, lifting the front edge slightly to slide past lock “stop.”

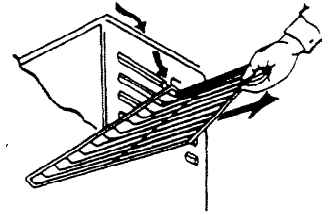

IMPORTANT NOTE

To avoid damage to oven elements or uneven baking, do not place aluminum foil on oven bottom, on oven heating element or cover entire oven rack.

- Use oven temperature setting recommended in recipe or cookbook.
 - The oven temperatures for baking range from 170°F to 550°F and can be programmed at 5°F increments.
 - For PREHEATED BAKING, set oven control as described in following sections. Oven control will beep once when oven has reached selected temperature. After oven has beeped, place food in oven and bake for desired amount of time.
- See page 16 for steps to adjust oven temperature.

TO SET OVEN FOR BAKE:

Follow these steps for normal baking. Always place oven racks in position while oven is cool. Use the oven timer as described on page 13, if desired.

1. Push BAKE button once. (Time of day will remain in display.)

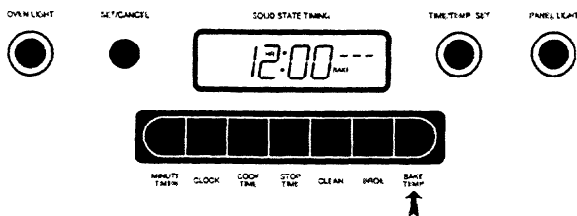

2. Turn TIME SELECT knob clockwise to select the desired oven temperature. The selected temperature will appear in upper right hand corner of the display. (Example shows setting of 350°F.)

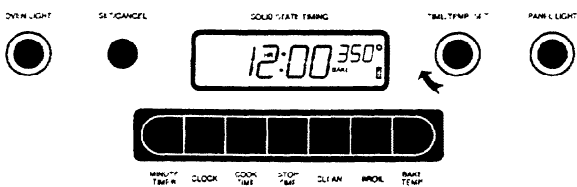

Oven will turn on and temperature displayed will start at 100°F until oven heats above that temperature. Oven temperature will rise in 5°F increments until selected temperature is reached. (Oven will beep once when this temperature is reached.)

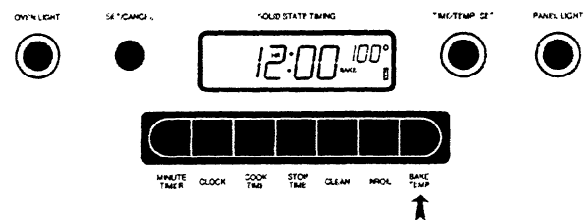

3. **For non-preheated baking:**

Place food in oven before programming oven control.

For preheated baking:

The oven control will beep once when the oven has reached the selected temperature. After oven control has beeped, place food in oven.

4. When baking is completed (or to cancel the program at any time), push CANCEL button once to turn oven off. Open door carefully to allow hot air or steam to escape, then remove food. Display will show time of day.

TO SET OVEN FOR TIME BAKE:

You can set the oven to automatically start baking **now**, cook for a selected length of time and automatically stop later. This timed baking is recommended for foods of highly perishable nature, such as milk, eggs, fish, stuffings, poultry and pork.

1. Check to see that oven clock is set correctly. Set correct time if necessary (page 13).
2. Push OVEN TIME button once. Display will show "OVEN TIME" and ":00."

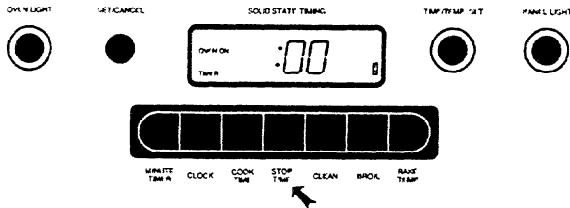

3. Turn TIME SELECT knob clockwise for desired length of baking time (hours:minutes); for example 2:30 for 2 hours and 30 minutes.

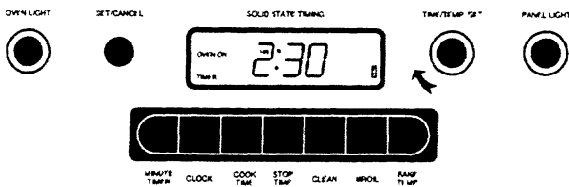

4. Push BAKE button once.

5. Turn TIME SELECT knob clockwise to select desired oven temperature. The selected oven temperature will appear in upper right hand corner of the display; for example 350°F.

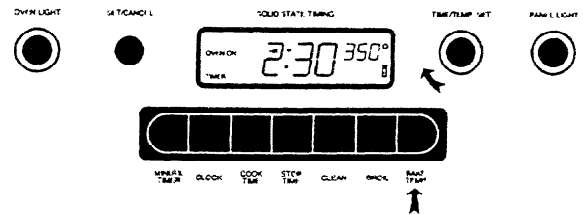

Oven will turn on and temperature displayed will start at 100°F until oven heats above that temperature. Oven temperature will rise in 5°F increments and the oven will beep once when the selected temperature is reached. Programmed bake time will count down.

- Push CLOCK button to display time of day. Push OVEN TIME button to return to amount of bake time left.
 - Push and hold in BAKE button to check programmed oven temperature.
6. After oven time has elapsed, the oven control will beep three times, the oven will shut off automatically and time of day will return to display. Remove food from oven promptly or it may overcook.
 7. Push CANCEL button to cancel program at any time.

CAUTION

To reduce the risk of food poisoning due to bacterial growth and the production of toxins: never hold meat, poultry, milk, eggs, or fish products more than two hours.

- The safest foods to use are frozen casseroles and main dishes, or non-frozen soups or casseroles which do not contain meat, milk, eggs or fish.

TO SET OVEN FOR DELAYED AUTOMATIC BAKE:

You can set the oven to automatically turn on **later**, cook for a selected length of time and then turn off at the time you want the food ready. This method of timed baking is not recommended for highly perishable foods such as meat, poultry, milk, eggs and fish products since this may create a health hazard.

1. Check to see that oven clock is set correctly. Set correct time if necessary (page 13).
2. Push OVEN TIME button once. Display will show "OVEN TIME" and ":00".

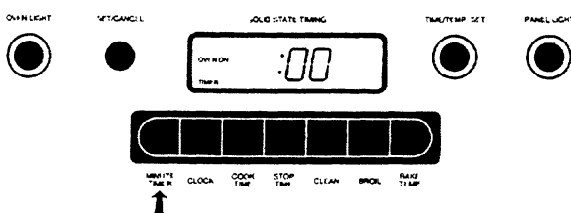

3. Turn TIME SELECT knob clockwise for desired length of baking time (hours:minutes); for example 2:30 for 2 hours and 30 minutes.

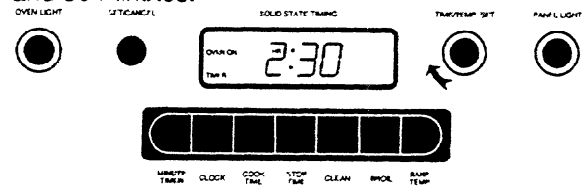

4. Push STOP TIME button once. The display will show the sum of the present time of day plus the selected length of baking time. For example, if the time of day is 1 o'clock and the selected baking time is 2 hours and 30 minutes, the display will show 3:30.
5. Turn TIME SELECT knob clockwise until the time of day when you want food to stop cooking appears in the display. For example 6 o'clock will appear as 6:00. This must be within 12 hours since this is a twelve hour clock.

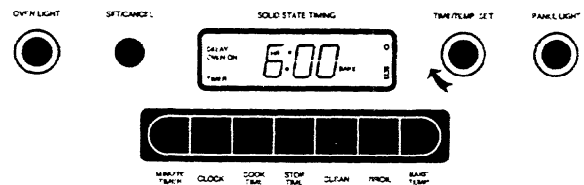

CAUTION

To avoid the risk of fire or property damage: never attempt to broil using the automatic setting.

Broiling should be watched closely and should never be done unattended.

6. Push **BAKE** button once.
7. Turn **TIME SELECT** knob clockwise to select desired oven temperature. The selected oven temperature will appear in upper right hand corner of the display; for example 325°F.

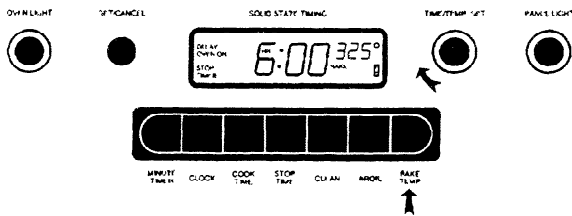

The oven is now programmed for the delayed start ("DELAY" will show in display). The oven control will calculate the time of day that the oven will turn on automatically to cook the food for the selected length of

baking time. (For example, the oven will automatically turn on at 3:30 to cook for 2 hours and 30 minutes and then shut off automatically at 6:00, the selected stop time.) The oven will beep once when selected oven temperature is reached.

- Push **CLOCK** button to display current time of day, if desired.
 - Push **OVEN TIME** button to check amount of bake time left. Push **STOP TIME** button to return display to selected stop time.
8. When stop time is reached, the oven control will beep 3 times, the oven will shut off automatically, and time of day will return to display. Remove food promptly or it may overcook.
 9. Push **CANCEL** button to cancel this operation at any time.

HOW TO ADJUST OVEN TEMPERATURE

The oven has been calibrated at the point of manufacture. However, if after using the oven for a period of time you wish to adjust the oven temperature to make it bake hotter or cooler, follow these steps. The oven temperature can be set $\pm 35^\circ\text{F}$.

1. Push **BAKE** button once.
2. Turn **TIME SELECT** knob clockwise until an oven temperature greater than 500°F shows in the display.
3. Immediately push and hold the **BAKE** button until "00" appears in the display (approximately 5 seconds).
4. **To decrease the oven temperature** (for cooler oven):
 - Turn **TIME SELECT** knob clockwise until the negative number (-05 through -35 in five degree increments) that represents the °F you wish to select appears. For example, if you want to decrease the oven temperature 20°F you select -20.

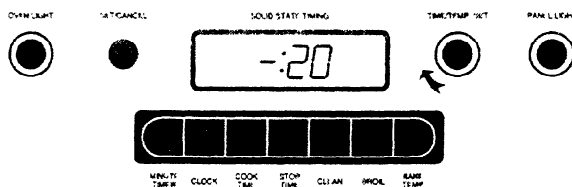

To increase the oven temperature (for hotter oven):

- Turn **TIME SELECT** knob clockwise past the negative numbers until the positive numbers (05 through 35 in five degree increments) appear. Select the number which represents the °F you wish to increase the oven temperature. For example, if you want to increase the oven temperature 15°F you select 15.

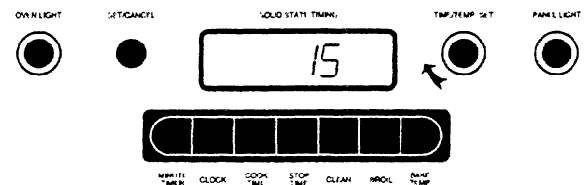

5. Push **CANCEL** button to enter this new oven temperature adjustment and return display to time of day.

Your oven bake and broil temperatures are now adjusted hotter or cooler as you have selected. This temperature adjustment is retained, even through power interruptions, until the oven temperature adjustment is reprogrammed.

BROILING

Your oven features a six-pass broil element with both HI and LO broiling operations. HI Broil can be used like a standard broiler to give even heating for most steaks, chops, and hamburgers. HI Broil operates at 590°F with the upper element on all the time during broiling. LO Broil operates at 490°F and the upper element cycles off and on allowing you to broil thicker foods without over browning the exterior surfaces. LO Broil works well for well-done meats, seafoods, and appetizers. See the Broil Chart on page 17 for suggested times and rack position.

IMPORTANT NOTE:

- **Do not use Teflon II[®] coated griddle or fry pan with nonremovable handle for broiling.**
- **Do not cover broiler grid with foil. It prevents fat from draining and can cause fire or smoke.**

Your oven is furnished with a porcelain broiler pan and chrome-plated grid. To minimize clean-ups, the pan may be lined with foil, but foil should never be placed on top of the chrome-plated grid during broiling; it will trap grease near the heating element and may cause it to smoke or catch fire. The broiler pan may also be used for roasting.

BROILING CONT.

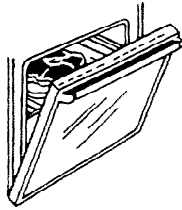

PRIOR TO BROILING:

- Arrange food on grid of broiler pan. See chart below for broiling times and rack placement. Always use grid as it allows fat to drip away from the meat as it cooks, thus reducing smoking. A small amount of water (about 1/2 cup) in the bottom of the broiler pan (under grid) also helps cut down on smoke.
- Check to see that the oven vent is not covered.

Note: Leave door ajar at "Broil" position for broiling operations.

Food	Doneness	Quantity and/or Thickness	Broil Operation	Rack Position*	First Side (Minutes)	Second Side (Minutes)	Comments
Hamburgers	Well Done	1 lb. (4 patties) 1/2 to 3/4-inch thick	HI	2	6-8	3-4	Up to 6 patties take about same time.
Beef Steaks	Rare	1-inch thick (Ribeye) (about 1/2 lb. each)	HI	2	6	6	Slash fat. Salt meat after broiling to prevent drying meat out.
	Medium		HI	2	9	8-9	
	Well Done	LO	2 or 3	15-17	11-13		
	Rare	1 1/2-in. thick (T-bone) (about 3/4 to 1 lb. each)	HI	2	7	6-7	
	Medium		HI	2	10	10	
Well Done	LO	2 or 3	15-17	11-13			
Chicken		Chicken quarters (2 to 2 1/2 lb.)	LO	2	15-18	10	Broil with skin side down first.
Fish		Fillets 1 lb. (1/4 to 1/2-inch thick)	HI	2	5	3-5	Handle and turn carefully.
		Steaks (1-inch thick)	LO	2	7	4-5	Brush with butter if desired.
Pork Chops	Well Done	2 (1/2-inch thick) 2 (1-inch thick)	LO	2	11-13	11-13	Slash fat to prevent edges from curling.
			LO	2	15-16	10-14	
Lamb Chops	Medium	2 (1-inch thick) about 1/2 lb. each	HI	2	6-8	6-8	Slash fat to prevent edges from curling.
	Well Done		LO	2	9-10	9-10	

*Rack Positions – Rack 1 is at the top of oven and Rack 5 is at the bottom of the oven.



CAUTION

To avoid the risk of fire, personal injury or property damage, use the broiler grid only in the proper position. If it is put in upside down, grease will collect in the rim and could be hazardous. Do not use abrasive cleansers to clean the broiler pan or grid, these may scratch the finish.

TO SET OVEN FOR BROIL:

1. Press BROIL button once. Time of day will remain in display.

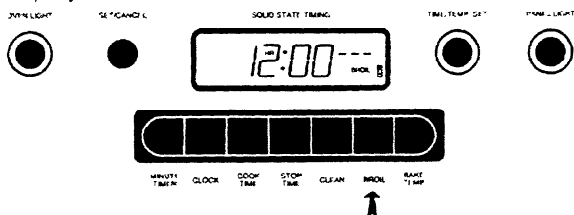

2. Turn TIME SELECT knob to select HI or LO Broil. (See broil chart for suggestions.)
For HI Broil: Turn TIME SELECT knob to the right (clock-wise) to the second position and "HI" will appear in display.

For LO Broil: Turn TIME SELECT knob to the right to the first position. "LO" will appear in display. (If you passed the first position, HI will appear. Turn knob back to the left until LO appears.)

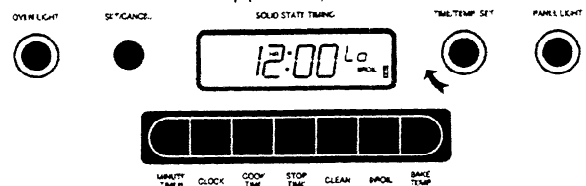

3. "ON" will appear in display indicating the broil element has turned on. The broiler (upper) element operates alone for broiling.

For preheated broiling:

Leave oven door closed for amount of time suggested in the recipe. If recipe calls for preheated broiling but does not give a preheat time, try three minutes. Proceed as follows by placing food in oven and leaving door ajar during broiling.

4. Center broiler pan under the broil element on the suggested rack. Leave door ajar at the "Broil" position (open about 5 inches).
5. Use timer, if desired, as instructed on page 13.
6. Press CANCEL button once to turn oven off when broiling is completed or if a programming error has been made. Remove broiler pan from oven. . .if pan and grid are left in heated oven they will be more difficult to clean. See page 21 for further instructions on cleaning broiler pan and grid.

SELF-CLEANING THE OVEN

BEFORE OPERATING SELF-CLEAN CYCLE:

1. Allow oven to cool after baking or broiling. The oven cavity must be cooler than 400°F before oven can be programmed for self-clean cycle.
2. Remove condiment containers, plastic spoons, holders, etc., from top surface of range. Do not obstruct oven vent located on lower right side of control panel.
3. Remove all pots, pans, broiler pans and anything else that may be stored in the oven.

Be sure oven is cool before completing the following steps.

4. Remove oven racks. If the oven racks are left in the oven during self-cleaning, they permanently discolor and warp. Therefore, it is recommended that oven racks be removed before self-cleaning oven.
5. Wipe excessive grease and spillovers from bottom of oven. Heavy spillovers that can be readily wiped up should be removed from the oven before the cleaning cycle is started. These thick spillovers keep the cleaning heat from reaching the bottom of the spillover and could leave small dark uncleaned spots. Removing the heavy spillovers also helps eliminate excessive smoking during the self-cleaning cycle. The lower heating element lifts up for ease in removing these spillovers.
6. Remove all soil from (see drawing at right):
 - A • oven frame (including 1-inch inside cavity where closed door rests)
 - B • side of raised portion on door
 - C • door liner (area around raised section on door)

Wipe entire surface even though it may not appear dirty. The reason is that heat will cause sometimes unnoticeable soil and spatters to bake on and they will be more difficult to remove after the self-cleaning cycle. If necessary, sponge areas (A, B, C) with detergent water or mild cleanser and use nylon scouring pads or steel wool soap pads to remove excess soil. Rinse areas well.

REMEMBER:

- Do not use harsh abrasives, chemicals or any of the commercial chemical-type cleaners on the exterior or interior of the range.
- Do not use chemical oven cleaners. If cleaners are not entirely removed (they are not always visible), they may have a reaction with oven interior at the high temperature of the self-cleaning cycle, causing etching of oven interior.
- **Do not scrub or clean woven oven gasket.**

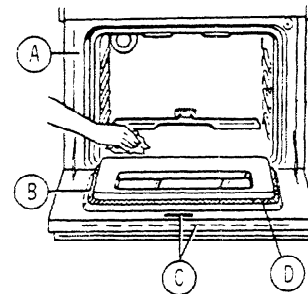

NOTE: Surface cooking elements may be used during the self-clean cycle.

PRIOR TO SETTING THE SELF-CLEAN OVEN:

1. (Read: "Before operating self-clean cycle" above.) Check inside of oven and remove any items.
2. Make sure oven vent is not obstructed.
3. Close oven door.

The self-clean cycle is preprogrammed for 3½ hours which cleans normal soil in your oven. If oven is excessively dirty, make sure large spills are wiped up. If oven is still dirty after the self-clean cycle, repeat the cleaning operation, if necessary.

CAUTION

To avoid the risk of burns do not touch areas above the oven door and in front of the oven vent (located on the lower right side of back-splash). These areas become hot enough to cause burns during the self-clean cycle.

TO SET THE SELF-CLEAN CYCLE TO START NOW:

1. Push CLEAN button once. "CLEAN TIME" and dashes will appear in display.

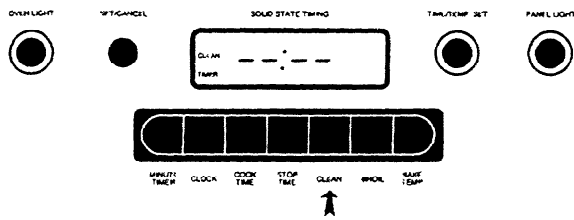

2. Turn TIME SELECT button clockwise until "3:30" appears in display. 3½ hours of clean time has been preprogrammed for you.

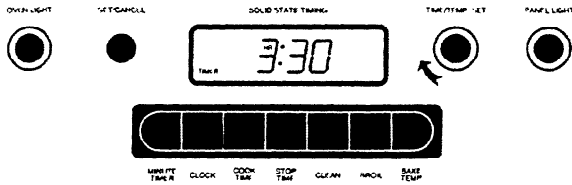

3. After a short pause, the oven will turn on and you will hear the oven door automatically lock (by the latch at the top edge of the oven door).

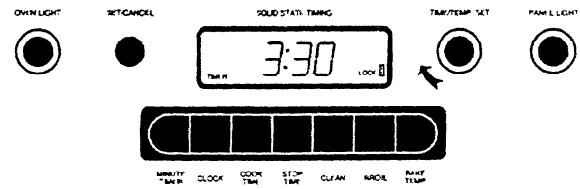

The cleaning time in the display will count down. Press the STOP TIME button to see the time of day when clean cycle will be finished, then press CLEAN button to return display to show remaining clean time.

See page 20 for further details on self-cleaning.

TO SET THE SELF-CLEAN CYCLE TO START LATER:

1. Check to see that oven clock is set correctly (see page 13) and the steps for preparing the oven prior to self-cleaning have been followed.
2. Push STOP TIME button once. "STOP TIME" and time of day remains in display.

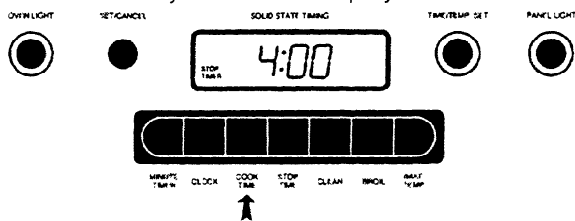

3. Turn TIME SELECT knob clockwise to the time of day when you want the self-clean cycle to be finished (this time must be at least 3½ hours past the current time of day on clock). The oven control will automatically calculate the time of day the self-clean cycle will start.

For example, if the current time of day is 4:00 p.m. and you want to set the self-clean cycle to be finished at 9:00 p.m., set the stop time for 9:00. The oven will automatically turn on at 5:30 p.m. and then turn off at 9:00 p.m.

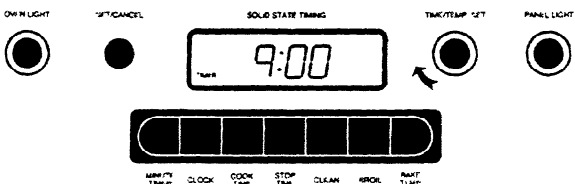

4. Push CLEAN button once. "CLEAN TIME" and dashes will appear in display.

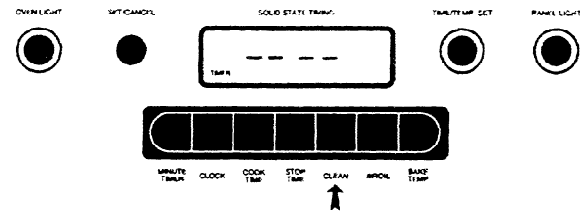

5. Turn TIME SELECT knob clockwise until "3:30" appears in display. 3½ hours of clean time has been preprogrammed for you. After a short pause, the oven door automatically locks.

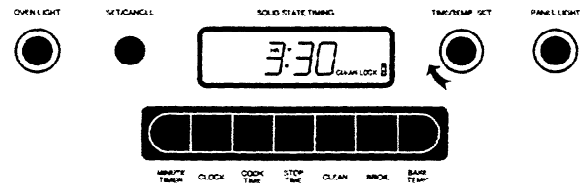

The oven is now set for a delayed start. The oven will not turn on until the clock reaches the calculated start time. The "ON" will appear in the display when the self-clean cycle starts. The cleaning time will then count down.

NOTE: Since this is a twelve hour clock, the maximum amount of time you can program for delay is 12 hours.

WHAT HAPPENS DURING SELF-CLEAN CYCLE:

- During the two stage self-clean cycle, the broil element operates for the first 15 minutes of cleaning and the bake element operates for the remaining clean time.
- The temperature will continue to rise to about 900°F where it will stay for the remainder of the cleaning time. (**NOTE:** The first few times the self-cleaning system is used, there may be minor smoking and a slight odor as the oven insulation "cures." This will disappear after the first few cleaning cycles.)
- The vapor and smoke generated during the self-clean cycle is catalytically cleaned before being discharged into the room.
- The oven vent exhausts vapor and warm air during self-clean cycle. It should always be left unobstructed.
- You may notice some wisps of smoke from around the door or oven vent at the beginning of the cleaning cycle.

SAFETY FEATURES:

- The "locking system" during the self-clean cycle is designed so that the door can NOT be opened when oven reaches a temperature of approximately 500°F ("LOCK" is on). The oven will remain locked as the temperature continues to rise to about 900°F, during the remainder of the self-clean cycle and until the oven has cooled to a safe temperature. The oven will unlock when the temperature drops to about 400°F.
- The range has UL designation (located on the nameplate) which shows it has passed Underwriters' Laboratories, Inc. safety tests.

TO INTERRUPT OR CANCEL SELF-CLEAN CYCLE:

1. Push CANCEL button once. This cancels all programming functions.
2. Display will return to time of day. Allow oven to cool. If oven is still hot, the door will remain locked (as indicated by "LOCK" in display) until the oven has cooled to a safe temperature. When the "LOCK" indicator turns off and the door unlocks, you may then open the door carefully, allowing warm air to escape.

AFTER SELF-CLEAN CYCLE IS FINISHED:

The oven temperature will drop and when a safe temperature is reached (approximately 400°F), the door will automatically unlock and "LOCK" will disappear from the display. Time of day will return to the display.

1. Leave door ajar to finish cooling oven.
2. Remove any ash from bottom of oven with a damp paper towel. If small, dark burned-on spots remain inside the door or in the oven they may require some manual cleaning.
3. Remove any baked-on soil from around oven door and oven frame with damp cloth and cleanser.
4. If necessary, lubricate sides of oven racks lightly with a little cooking oil. The racks will slide more easily and the oil prevents friction and possible damage to oven rack supports.

OVEN SELF-CLEANING HINTS:

- A convenient time to self-clean the oven is in the evening, when normal oven use is completed.
- It is normal to notice a slight amount of smoke escaping around the upper part of door during self-cleaning when the soil is heavy. Excessive smoke may indicate excessive spillovers have not been wiped up or there may be a faulty gasket which should be checked by an authorized servicer.
- The oven should be cleaned before it gets "excessively dirty" – which means something different to every cook! If the oven is not clean after one cycle, repeat cleaning cycle.

STORAGE DRAWER

The storage drawer is for storing pots and pans. The drawer can be removed to make it easier to clean under the range. Be sure to use care when removing and replacing the drawer.

To Remove the Storage Drawer:

1. Pull the drawer straight out to the first stop. Lift the front of the drawer and pull it out to the second stop.
2. Let the front of the drawer rest on the floor. Place your hands toward the back of the drawer and lift it out.

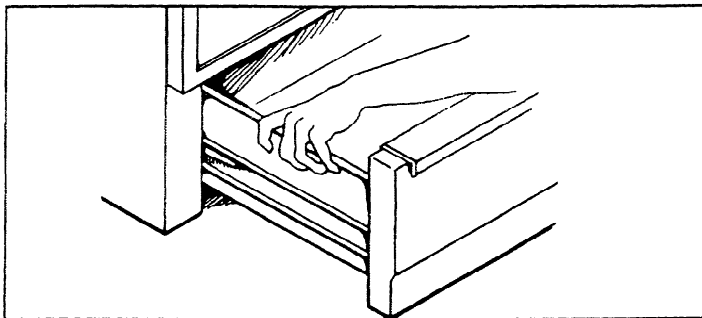

Figure 1

To Replace the Storage Drawer:

1. Place the set of rollers on the drawer behind the set of rollers on the oven. (As shown in Figure 2)
2. Line the guides up with each other and push the drawer back into position.

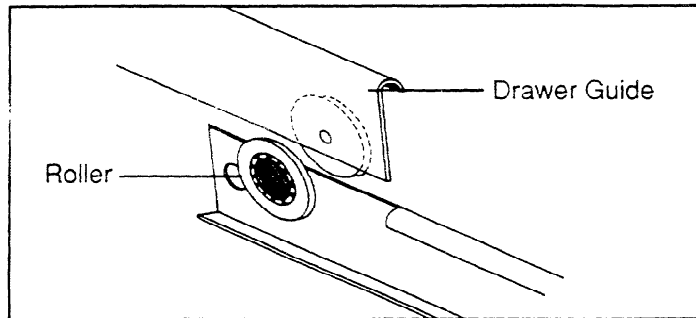

Figure 2

NORMAL CARE AND CLEANING



CAUTION: TO AVOID BURNS ALLOW OVEN PARTS TO COOL BEFORE TOUCHING OR HANDLING.

Proper care and cleaning procedures are essential for a long and satisfactory life for your oven.

Part	Materials to Use	General Directions
Bake Element and Broiler Pan and Grid		Do not clean the bake element or broil element. Any soil will burn off when the element is heated. NOTE: The bake element is hinged and can be lifted gently to clean the oven floor. If spillover, residue, or ash accumulates around the bake element, gently wipe around the element with a damp cloth and warm water.
Broiler Pan and Grid	<ul style="list-style-type: none"> • Soap and Water • Soap-Filled Scouring Pad • Nonabrasive Plastic Scouring Pad 	Drain fat, cool pan and grid slightly. (Do not let soiled pan and grid stand in oven to cool.) Sprinkle with soap. Fill the pan with warm water. Let pan and grid stand for a few minutes. Wash; scour if necessary. Rinse and dry. OPTION: The broiler pan and grid may also be cleaned in a dishwasher.
Oven Control Knobs	• Mild Soap and Water	Pull off knobs. Wash gently but do not soak. Dry and return controls to oven, making sure to match flat area on the knob and shaft.
Outside Finish Glass Door Front and Backsplash	• Soap and Water	Wash all glass with cloth dampened in soapy water. Rinse and polish with a dry cloth. If knobs are removed, do not allow water to run down inside the surface of glass while cleaning.
Metal, including Chrome	• Soap and Water	Wash, rinse, and then polish with a dry cloth. DO NOT USE steel wool, abrasives, ammonia, acids, or commercial oven cleaners which may damage the finish.
Inside Oven Door*	• Soap and Water	Clean ONLY the door liner outside the gasket. Door is automatically cleaned when oven is in self-cleaning cycle. If spillover or spattering occurs when cooking, wipe door with soap and water. DO NOT rub or damage gasket. Avoid getting soap and water on gasket or in slots in door.
Oven Gasket*		Avoid getting ANY cleaning materials on the gasket. Do not clean or scrub woven gasket!
Oven Interior Surfaces*	• Soap and Water	Cool before cleaning. Frequent wiping with mild soap and water will prolong the time between major cleanings. Be sure to rinse thoroughly. For heavy soiling, use your self-cleaning cycle.
Oven Racks	• Soap and Water	For heavy soil, clean by hand and rinse thoroughly.
Storage Drawer	• Soap and Water	Remove drawer: pull out as far as possible. Pull front edge up until stud on glide rails is cleared. Replace drawer by sliding it onto the glide rails, making sure that the stud on the glide rails is in the matching slot on the drawer.

*Spillage of marinades, fruit juices, and basting materials containing acids may cause discoloration. Spillovers should be wiped up immediately, with care being taken to not touch any hot portion of the oven. When the surface is cool, clean and rinse.

HOW TO REPLACE THE LIGHTS

CAUTION

To avoid the risk of burns or electric shocks:

- Disconnect the electric current to the appliance at the wall outlet fuse or breaker box.
- Wait until the oven and/or light bulbs are cool.

HOW TO REPLACE OVEN LIGHTBULB:

To remove glass globe:

- Hold hand under glass cover to prevent its falling when released.
- Turn the glass cover counterclockwise to remove.

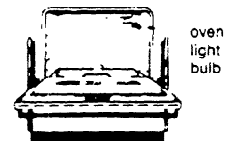

To replace the light bulb:

- Turn the bulb counterclockwise to remove. (A dry oven mitt or cloth will protect against broken glass.)
- Replace with a 40-watt appliance bulb, rotating it clockwise.
- Secure the glass cover over the bulb by rotating clockwise.

IMPORTANT NOTE

Do not overtighten the light bulb cover. After repeated use of the oven, a cover that is too tight will be very difficult to remove

COMMONLY ASKED QUESTIONS

1. **Q. What cookbook is suggested for use with my new electric range?**
 - A. Range temperatures are standardized. For instance, 350°F will be consistent from one oven brand to another. We suggest consulting a basic cookbook such as *Betty Crocker* or *Better Homes and Gardens*. These cookbooks contain basic baking and cooking times and temperatures.
2. **Q. I've put an oven thermometer in my oven and noticed it does not maintain a constant temperature. Do I have a problem?**
 - A. To maintain a temperature for baking, your Amana oven will cycle off and on. You may see a "swing" in temperature of as much as $\pm 25^{\circ}\text{F}$, but the average will be the temperature desired. This temperature cycling is considered a normal procedure in range operation.
3. **Q. Is it normal for my rangetop to get warm during use?**
 - A. The porcelain rangetop may become warm to the touch while the range is being used to bake, broil, or self-clean. The longer the range is operated, the more the heat can be conducted to the rangetop.
4. **Q. When broiling, is it necessary to always use a grid in the pan?**
 - A. Yes. Using the grid suspends the meat over the pan. As the meat cooks, the juices fall into the pan. Drippings are protected under the grid and stay cooler, thus preventing excessive spatter and smoke.
5. **Q. Must the Clock be set on correct time of day when I wish to use the Time Bake or Delayed Automatic Bake features?**
 - A. Yes. Set the clock for the correct time of day to ensure proper operation of timed functions.
6. **Q. Can I use the Timer during oven cooking?**
 - A. The Timer can be used during any cooking function and is especially handy when baking or broiling. The Timer can also be used to time other kitchen activities while you are using the automatically timed functions.
7. **Q. If my range clock is not working, can I still self-clean my oven?**
 - A. No. Your oven control uses the oven clock to help start and stop your self-clean cycle.
8. **Q. Should there be any odor during the cleaning?**
 - A. Yes. There may be a slight odor during the first few cleanings. Failure to wipe out excessive soil might also cause an odor when cleaning.
9. **Q. What should I do if excessive smoking occurs during cleaning?**
 - A. This is caused by excessive soil, and you should press the CANCEL button to shut oven off. Open windows to rid room of smoke. Allow the oven to cool and unlock before attempting to open the door. Wipe up the excess soil and reset the self-clean cycle.

SERVICE TONES

If the oven control sounds a series of short, rapid beeps and the display shows a diagnostic service code (F0-F9), there may be a problem with the electronic oven control.

If this has occurred while you were programming the oven control, push the CANCEL button and try to reprogram the oven control. If the service tone continues and doesn't stop within 16 seconds, push the CANCEL button. If you are unable to cancel the beeping with the CANCEL button, unplug the range or disconnect the circuit breaker. Next, contact your nearest authorized servicer and indicate which diagnostic service code has appeared in your oven's display.

Each diagnostic service code indicates which part of the control or oven needs to be checked by the servicer.

F0 – indicates a problem with the CANCEL button operation.*

F1 and F7 – indicate a possible short in the control.*

F2 – indicates an excessively high bake/clean temperature.

F3 and F4 – indicate a problem with the oven's temperature sensor. The service tone will occur again when the oven is used for bake, broil or clean operations until checked by a servicer.

F5 and F8 – the control will reset to a non-bake mode. The service tone will occur again when the oven is used for bake, broil or clean operations.

F6 – the control will not sound a service tone when this code appears in the display. The control may reset to a non-bake mode.

F9 – indicates the door lock mechanism may need to be checked by a servicer.*

Fd – indicates bake or broil elements need to be checked by a servicer. The oven control will reset to a non-bake mode.

* If any of these service codes appear in display, the range must be unplugged or power must be disconnected until it has been serviced. Help the servicer give you prompt service by informing them which service code has appeared in your display. See page 21 for more service information.

If the electronic control should ever flash through different features, you have probably programmed the sales-demo mode. Press the CANCEL button to clear the display and return to the time of day.

BEFORE CALLING FOR SERVICE

Make sure you have followed instructions in your Use and Care Manual. Avoid unnecessary service calls for difficulties that are not a result of defective workmanship or materials. You will be charged for a service person's travel expenses and labor, even though the product may be under warranty, if the difficulty is not caused by workmanship or materials, or if that component is considered customer replaceable. The following items are considered customer replaceable: oven racks, lightbulbs, control knobs which can be removed by pulling off the control shaft. The heating elements in the rangetop can be replaced individually by an authorized servicer.

- If range does not heat, check the power source (fuse or circuit breaker).
- Review use and care instructions.
- Check the suspected defect a second time.
- If clean cycle does not start:
Check to see that oven is not set for a delayed start.
- If any surface unit fails to heat, follow the appropriate performance test below.

PERFORMANCE TEST FOR SURFACE HEATING ELEMENTS:

If there seems to be a problem with any of the surface heating elements, use this performance test to check if the element is heating properly.

1. Use a flat-bottom, medium- to heavy-gauged metal pan which matches the size of the element.
2. Pour 1 quart of tap water (65 to 70°F) into saucepan, cover with lid and place on element to be tested.
3. Turn control knob to HI and time the number of minutes it takes for the water to come to a complete boil. **NOTE:** The amount of time it takes for the water to boil will depend on the flatness of the pan and the initial temperature of the water. If the pan is not flat (use technique on page 7 to determine flatness) the boiling times can be increased to 10-12 minutes. If your boiling time is excessively long and you have used a covered, flat-bottomed metal pan for testing, there may be a malfunction in the element and service may be required.

WHEN SERVICE IS REQUIRED

The dealer from whom you purchased the range can give you the name of your nearest Authorized Service Center. Help them give you prompt service by giving them:

1. An accurate description of the trouble.
2. Complete model, serial, and manufacturing numbers located on oven frame below oven door - open storage drawer to see plate. (Listed on silver nameplate.)
3. Proof of purchase (sales receipt on request).

Repair by an unauthorized servicer that results in subsequent failure will void the warranty. Warranty details are contained in the warranty certificate enclosed with this booklet.

Keep an accurate record of any service calls: what was done, who serviced the range, and the date of service.

Amana has a vast network of Authorized Service Centers in the U.S. However, if you should have a service problem that is not resolved locally,

Write: Consumer Affairs Department
Amana Refrigeration, Inc.
Amana, Iowa 52204

For quicker service, or for answers to questions concerning product usage, installation, and warranty, call:

CONSUMER INFORMATION LINE



TOLL FREE

1-800-843-0304

Rest assured against unexpected repair bills!

Asure

EXTENDED SERVICE PLAN

Amana is pleased to offer an important opportunity for long-term service protection on your new Amana appliance. The Asure Extended Service Plan is specially designed to supplement the strong warranty that already accompanies your appliance, and it combines with this standard warranty to provide budget-protecting coverage on your appliance for up to five full years, covering parts, labor and travel charges.

Please contact us at:

Amana Refrigeration, Inc.
Consumer Affairs Department
Amana, Iowa 52204
1-800-843-0304
Monday through Friday
(Normal Business Hours)

Lined area for notes or specifications.